

A Comparative Study on the Production of Galacto-oligosaccharide from Whey Permeate in Recycle Membrane Reactor and in Enzymatic Batch Reactor

Ranjana Das, Dwaipayan Sen, Ankur Sarkar, Saurav Bhattacharyya, and Chiranjib Bhattacharjee*

Department of Chemical Engineering, Jadaupur University, Kolkata-700032, India

The present study primarily is an attempt to establish a technique on the disposal scheme for the wastewater coming out as an effluent from milk industries with proper environmental guides and regulations. Apart from the wastewater treatment methodology development, the present work mainly focuses on the attainment of high value product, such as the production of galactosyl-oligosaccharide (GOS) in batch reactor and as well as in recycle membrane reactor after hydrolyzing recovered lactose from the whey stream with β -galactosidase enzyme originated, from *Bacillus circulans*. Around 77–78% purity of this GOS was achieved with three-step membrane separation techniques: the first one was the ultrafiltration followed by diafiltration equipped nanofiltration. In recycle membrane reactor, GOS production was found to be 33% higher than that in the batch reactor, and monosaccharide concentration was 78% lower with 23% remaining enzyme activity after 18,000 s of reaction time.

1. Introduction

Implementation of strict norms against chemical additives in food and pharmaceutical industries insists many researchers search for an effective and safe natural resource for food additive, or, in other words, functional foods. Current nutritional research activity is now leaning toward the economic production of nutraceuticals from cheap resources and thus showing an inclined interest toward the production of saccharidic natural substances from these resources, called “prebiotic” or “bio-preservative oligosaccharides”.¹ Oligosaccharides are defined as oligomers of monosaccharides, consisting of a galactosyl-glucose chain with terminating glucose unit, having a degree of polymerization between 2 and 10. Prebiotic oligosaccharides are noncarcinogenic, nondigestible, and low calorific compounds.¹ These oligosaccharides and their derivatives are important biomolecules, having a wide range of imperative functions effective within the biological systems. Primarily, these are the bifidogenic and stimulate the growth of gastrointestinal microflora.^{2,3} Quantification strategies for the prebiotic effect of such oligosaccharides are currently assayed in vitro on faecal batch cultures,⁴ followed by the creation of prebiotic index.⁵ In the current context of functional foods, oligosaccharides are playing a major role as functional ingredients as compared to dietary fibers, sugar alcohols, peptides, polyunsaturated fatty acids, and antioxidants.⁶ Because of the potential health benefits associated with the consumption of these compounds, their use as food ingredient has grown rapidly, particularly in Japan and Europe.⁷ Lactose is the potent raw material for the production of galacto-oligosaccharide (GOS), one of the most well-known oligosaccharidic compounds in the family of prebiotic oligosaccharides. Different strategies have been published on the chemical synthesis of oligosaccharides^{8,9} where chemical glycosylation seems truly nonrealistic for industrial purposes, and hence enzymatic synthesis using β -galactosidase is the mostly adopted method for the production of GOS from lactose.^{10,11} Grosová et al.¹² have highlighted the perspective and applications of β -galactosidase in lactose hydrolysis and also on other major applications in food industries. Instead of the efficacy,

shown by enzymatic hydrolysis of lactose using β -galactosidase, reverse transgalactosylation reactions lessen the yield of GOS apart from product inhibition effect.^{13–16}

Production of GOS is mostly carried out in batch reactor, where the enzyme inactivation is usually done by heat treatment after a certain reaction period to stop the reaction occurring. One of the most disadvantageous parts associated with the production of GOS is inhibition caused because by glucose and galactose produced during lactose hydrolysis. It is obvious that in normal batch mode operation this inhibition effect is more pronounced because of the presence of these two compounds in the reaction medium. So continuous recycling through the membrane could make an additional favorable impact on the whole process, where the glucose and galactose are continuously separated out from the medium and finally end up with the separation of GOS from other components to obtain GOS with maximum purity. Based on that, objectives of the present literature are 2-fold. One is to make a comparative study between enzymatic batch reactors and recycle membrane reactor with an objective to maximize the yield of GOS with minimizing the inactivation of enzyme. Second is the separation of GOS from the reaction mixture using discontinuous diafiltration (described in the Appendix) technique adopted on nanofiltration (NF) membrane separation.

Adaptation of diafiltration is now a state-of-art in food, biotech, and pharmaceutical industry to enhance the purity of the retained components on the retentate side, without having so much mechanical effort to enhance the permeation of the low molecular weight components through membrane.¹⁷ Especially this is true with the NF process, where the membrane fouling is more pronounced because of the interactions between solute and membrane at nanoscale level.^{18,19} This membrane fouling imparts a hindrance to the passage of the microsolute through membrane and thereby reducing the extent of purity of the components. With diafiltration, dilution of the retained solution on the membrane surface helps to disperse the fouling layer due to the accumulation of solutes and thus create a washing effect that magnifies the separation of the components by membrane. Therefore, to reduce this membrane fouling, especially with NF, the present study employs diafiltration technique to separate GOS with maximum purity using rotating

* To whom correspondence should be addressed. Tel.: +91 98364 02118. Fax: +91 33 2414 6203. E-mail: cbhattacharyya@chemical.jdvu.ac.in.

Table 1. Properties of Membranes Used in This Study

membrane	MWCO	specifications
TFC-SR2	0.4 kg mol ⁻¹	9.8% NaCl rejection pH: 4–9 maximum operating pressure: 3.45 MPa maximum process temperature: 318 K
Vivaflow 200	50 and 5 kg mol ⁻¹	active surface area: 0.0025 m ² dimensions: overall length/height/width: 0.126/0.138/0.038 m channel width/height: 0.01/0.0004 m pH: 2–14 maximum operating pressure: 0.4 MPa active surface area: 0.02 m ²

disk membrane module (RDMM), where membrane was rotated with a certain speed to create high shear on the membrane surface to enhance the separation.

Instead of using pure lactose in this process, whey permeate was used to understand that the process complexity could be attained in actual large-scale industry after implementation of the technology. Selection of whey protein as feed to the process also aiming to judge the extent of meeting the antipollution regulation demands that the dairy industry should develop with new technologies, which can change the role of whey from waste to valuable products.²⁰ Recovery of lactose from whey and its utilization for valuable nutraceuticals preparations solves both the problems encompassing the improved economics of whey utilization and pollution reduction, as lactose recovery itself can reduce the biological oxygen demand (BOD) value of whey by more than 80%.²¹ An in-depth realization of the lactose recovery from whey and its utilization will be achieved in the subsequent sections of this literature.

2. Materials

2.1. Ultrafiltration (UF) Module Specification. The 5 and 50 kg mol⁻¹ polyethersulfone (PES) UF membrane, purchased from Vivascience AG, Germany, was casted in a housing cross-flow module, called Vivaflow 200 supplied by the same manufacturer. Detailed specifications for this module are presented in Table 1.

2.2. Nanofiltration (NF) Membrane and Module Specification. TFC-SR2 membrane, of nominal molecular weight cutoff (MWCO) 0.4 kg mol⁻¹, was supplied by Koch Membrane Systems (San Diego, CA). According to the manufacturers, these membranes are polyamide thin-film composite with a microporous polysulfone supporting layer.²² Table 1 presents the properties of TFC-SR2 membrane. NF membrane was fitted in a module, called the rotating disk membrane module (RDMM).²³ Figure 1 shows a schematic diagram of this RDMM.

2.3. Reverse Osmosis Module Specification. An indigenously fabricated (make: Concept International) radial cross-flow reverse-osmosis module (radius: 0.038 m) was used in this study (Figure 2). The cell consists of an upper half flange and a lower base flange. The base flange houses the membrane (thin film composite on polypropylene, catalogue no. RO98pHt, make: Alfa Laval, possessing NaCl rejection $\geq 97\%$ measured with 2 kg m⁻³ NaCl solution at 1.55 MPa and 298 K) and a porous support. As per the manufacturer catalogue, all the membrane materials comply with FDA regulations (CFR) Title 21, and the membranes are thus suitable for use within food and pharmaceutical processing applications. Leakage was prevented by an “O” ring of neoprene rubber gasket. A diaphragm pump was used to continuously force the liquid through the cell, and the solution flows radially to the periphery. From the periphery, it goes to the feed tank through back-pressure regulator. Pulses are damped to an almost constant flow by employing a dampening device. The flow rate of feed was maintained constant at 3.055×10^{-8} m³ s⁻¹. The trans-

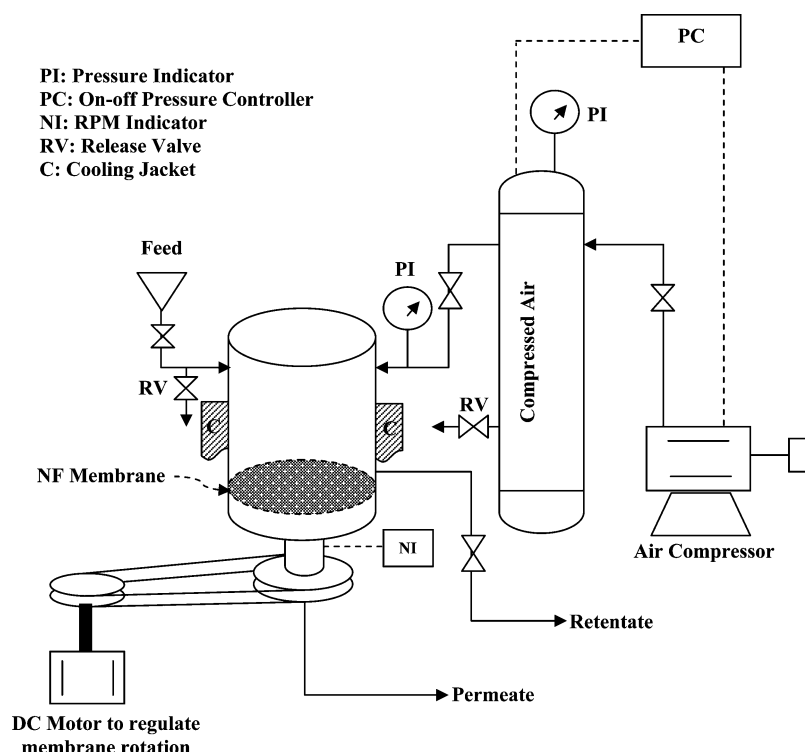

Figure 1. Schematic diagram of rotating disk membrane module fitted with nanofiltration membrane.

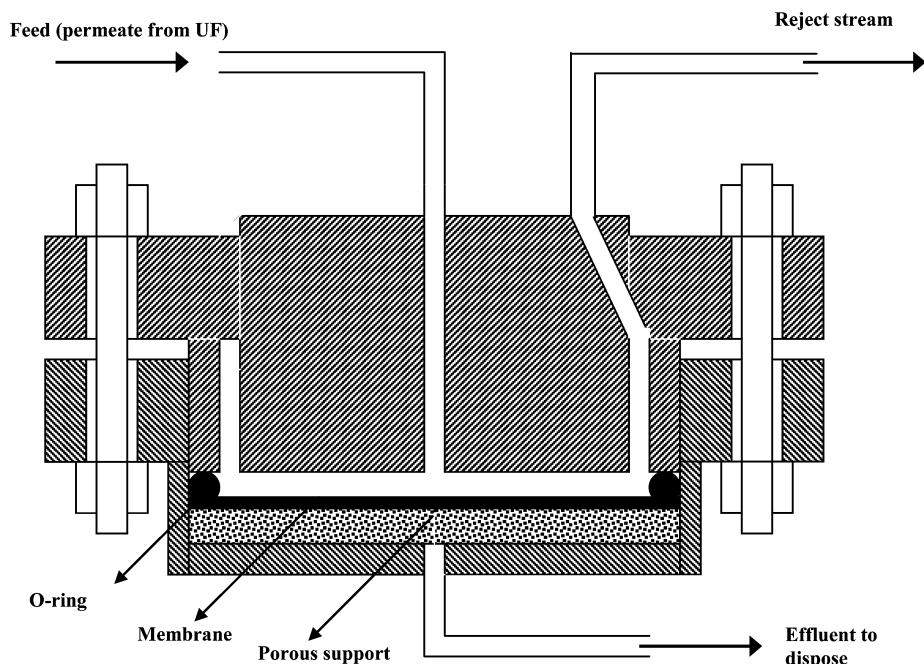

Figure 2. Cross-sectional view of the radial cross-flow cell.

membrane pressure (TMP) was set at 2 MPa, and the operation was continued at ambient temperature.

In a particular experimental run, first the wet membrane was placed on the porous support at the lower base flange. The cell was then assembled. To start with a new membrane, it is foremost to compact the membrane by pressurizing it with distilled water beyond the maximum operating pressure until steady flux was obtained. The flow rate was kept constant throughout the experiment. After the completion of each run, the cell was rinsed thoroughly with distilled water, and the water flux was again checked at stipulated pressures to monitor any change in membrane hydraulic resistance. It was observed that nearly 98% recovery of the water flux could be achieved after thorough cleaning of the membrane at the end of each runs. The detailed description and the operating characteristics of this setup are beyond the scope of the present study.

2.4. Analytical Instruments. Deionized (DI) water was collected from an ultrapure water system (model - Arium 611) of Sartorius AG, Germany. The feed for deionized water system was distilled water from reverse osmosis (RO) system (model - Arium 61315, make: Sartorius AG Germany). VARIAN UV-visible spectrophotometer (Cary50 Bio) was used for protein concentration measurement at 750×10^{-9} wavelength. HPLC (Perkin-Elmer, Series 200) with RI detector and Spheri 5 amino column (5×10^{-6} m, 4.6×10^{-3} by 220×10^{-3} m) was used with mobile phase of 75% (v/v) acetonitrile at a flow rate of $1.67 \times 10^{-8} \text{ m}^3 \text{ s}^{-1}$ for sugar analysis. Column oven temperature was maintained at 298 K. Concentrations of the sugars (glucose, lactose, and total oligosaccharides) should be proportional to their respective peak areas.²⁴ Chemical oxygen demand (COD) of the feed to the 5 kg mol^{-1} membrane, permeate, and retentate were measured using COD reactor (ET 108, Lovibond, Germany). In brief, $\text{COD } 2 \times 10^{-6} \text{ m}^3$ of stock solution was thoroughly mixed with $2 \times 10^{-6} \text{ m}^3$ of diluted sample solution and digested at 393 K for 3600 s in COD reactor. After being cooled, the samples were analyzed in a CHECKIT COD vario photometer.

2.5. Chemicals. Table 2 presents an average composition of nonhygroscopic whey powder (Industrial Product Specification No. 0149) that was procured from Burra Foods, Australia.

Table 2. Composition of Whey Powder

properties	amount
moisture	<3.0%
milk fat	<1.0%
protein	12.5%
ash (minerals)	7.5%
lactose	75%
titratable acidity (ADPI method)	0.12–0.15%
insolubility index	$0.1 \times 10^{-6} \text{ m}^3$
pH	5.9–6.1

Enzyme Biolacta FN5 (EC 3.2.1.23) extracted from *Bacillus circulans* (initial lactose activity, 4500 LU/g, Japan) was a kind gift from Burra Foods, Australia. 1LU, abbreviated form of “lactose unit”, is defined as the amount of enzyme required to produce 10^{-6} mol of glucose per minute from lactose at the early stage of reaction at 313 K and pH 6. Folin-Ciocaltau’s Phenol reagent (AR grade, 2 N), used for protein analysis,²⁵ was supplied by SISCO research laboratory private limited. Lactose, glucose, and galactose were purchased from SISCO Research Laboratory Pvt. Ltd., Mumbai, India. GOS was procured from Quingdao FTZ United International Inc. (Japan). Ethanol (AR grade) was purchased from Merck, Germany, and sodium hypochlorite (Approx. 4% w/v available chlorine, AR grade) was purchased from Merck, Mumbai, India. Australia. 1LU is defined as amount of enzyme, which liberates $1 \mu\text{mol}$ of glucose per minute from lactose at the early stage of reaction at 313 K and pH 6. All other chemicals otherwise stated were purchased from E. Merck, India.

3. Experimental Methods

3.1. Membrane Compaction and Water Run.²³ Prior to the experimental run both, NF and UF cross-flow membranes were subjected to compaction for about an hour with ultrapure water at a pressure of 1.4 and 0.275 MPa, respectively, higher than that of the highest operating pressure to prevent any possible changes in the membrane hydraulic resistance during filtration. Once the water flux became steady with no further decrease, it was concluded that full compaction of the membrane has taken place. Both the membranes were washed thoroughly

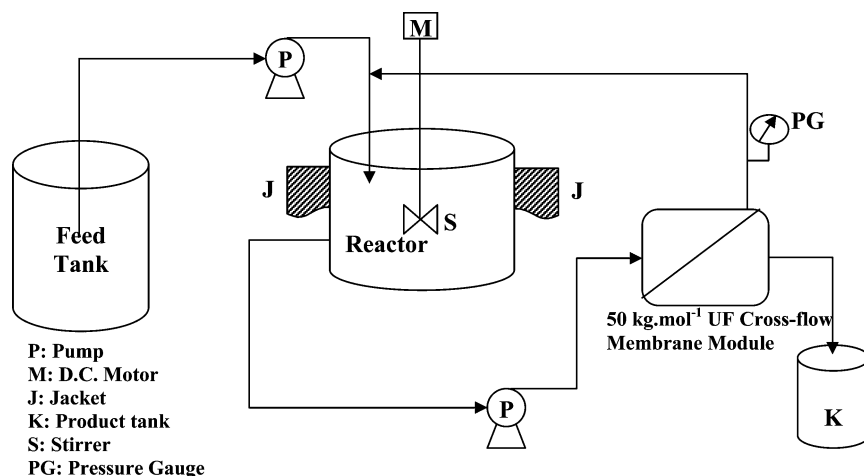

Figure 3. Schematic diagram of recycle membrane reactor.

with distilled water followed by chemical wash after every run to remove any deposited or adsorbed fouling layer. The water fluxes obtained from such studies were found to be within 2% of initial water flux, thus showing minimum fouling resulting from the proposed separation scheme. After the full compaction, water run was taken at three different operating pressures, less than that of the maximum pressure for compaction, with both the membranes to calculate the value of membrane hydraulic resistance (R_m). For 5 kg mol^{-1} membrane, the value was $1.43 \times 10^{13} \text{ m}^{-1}$, for 50 kg mol^{-1} membrane it was $2.33 \times 10^{12} \text{ m}^{-1}$, and for 0.4 kg mol^{-1} it was $1.12 \times 10^{14} \text{ m}^{-1}$.

3.2. Separation of Lactose from Whey. Lactose recovery from whey was carried out in 5 kg mol^{-1} cross-flow module with varying operating conditions to understand the extent of recovery. Cross-flow module could be operated at a maximum pressure of 0.4 MPa and temperature of 333 K, with pump flow rate in the range of 3.33×10^{-6} to $6.66 \times 10^{-6} \text{ m}^3 \text{ s}^{-1}$.²⁶ Before introduction of the feed to the membrane module, it was subjected to the microfiltration (MF) using “all glass vacuum filtration unit” (make: Sartorius A.G., Göttingen, Germany), equipped with an oil-free portable vacuum pump (Sartorius, A.G., Göttingen, Germany, model ROC 300 with moisture trap). Polyethersulfone (PES) membrane (pore size $0.45 \times 10^{-6} \text{ m}$) was used as filter media to the MF unit. Permeate from the MF was adjusted for pH 7.4 using sodium bicarbonate buffer to produce feed to the subsequent UF cross-flow module. A digital pH meter (Sartorius, Göttingen, Germany) was used to measure the solution pH with a resolution of 0.01.

Experiments were carried out batch-wise in a cross-flow module at different operating conditions, starting each time with a pretreated feed volume of $500 \times 10^{-6} \text{ m}^3$. At the time of run with 300 s interval of time, $2 \times 10^{-6} \text{ m}^3$ of permeate was collected and analyzed for protein concentration to understand the protein permeation to the permeate side. Different volume concentration factors (VCF) were maintained at each set of operating conditions in case of the cross-flow UF process. To maximize the recovery of lactose, three-stage diafiltration (see Appendix eq A.1) was carried out under each combination of operating conditions. Feed concentration or in actual whey powder concentration was varied from 0.1 to 0.4 kg m^{-3} with simultaneously varying the trans-membrane pressure (TMP) from 0.15 to 0.2 MPa. The pH of the solution in each case was maintained constant at 7.4. Dilute lactose solution, obtained as permeate after diafiltration operation, was again fed to the reverse osmosis cell to enrich the concentration

of lactose on the retentate side after removing the minerals as permeate.

3.3. Production of GOS in Batch Process. Lactose separated from whey was diluted to different concentrations varying from 5% to 30% (w/v) with 0.025 M potassium phosphate buffer (pH 6.6), and sufficient time was given for the mutarotation of lactose to attend in equilibrium. These solutions were inoculated with β -galactosidase originated from *Bacillus circulans*. Enzyme was added at 0.05–0.5% (w/v) levels. A reaction period of 5 h was maintained to carry out the reaction varying the temperature from 277 to 297 K. Samples from the reaction mixture were withdrawn at regular intervals of 1800 s and immediately heated at 368 K water bath for 278 K to stop enzymatic actions and thereby the reaction. Collected samples were analyzed for monosaccharides, disaccharides, and oligosaccharide by HPLC.

3.4. Production of GOS in Recycle Membrane Reactor. Recycle membrane reactor arrangement is shown in Figure 3. The lactose feed solution was taken from the feed tank and fed to the stirred tank using a peristaltic pump at a flow rate of $2 \times 10^{-8} \text{ m}^3 \text{ s}^{-1}$ at a TMP of 0.15 MPa. The reactor was equipped with an arrangement of cooling jacket to maintain a constant temperature during the reaction period. Reaction mixtures were subjected to a 50 kg mol^{-1} UF cross-flow module, and the permeate consisting of mainly carbohydrates was collected in the product tank. The retentate was recycled back to the reactor at the same rate as that of the reaction mixture at which it was taken away from the reactor. Finally, the permeate and retentate were analyzed in HPLC to study the extent of separation of the monosaccharide, disaccharide, and oligosaccharide from enzyme.

3.5. Separation of GOS Using NF Membrane. Permeate collected from the cross-flow module was mainly comprising of unreacted lactose and produced glucose, galactose, with oligosaccharides. This permeate was again fed to the RDMM NF membrane in conjunction with three stages of discontinuous diafiltration, varying the membrane speeds at 0.17 rps, to separate GOS from mono- and disaccharides. Separation was carried out at 1 MPa trans-membrane pressure (TMP) maintaining a constant temperature of 298 K.

3.6. Membrane Cleaning. Cleaning of the membrane module was performed according to the method described by Das et al.²⁶ Briefly, after each run, the system was kept in total recirculation with $200 \times 10^{-6} \text{ m}^3$ DI water. The PES membrane was cleaned with $250 \times 10^{-6} \text{ m}^3$ of 0.5 mM NaOCl in $250 \times$

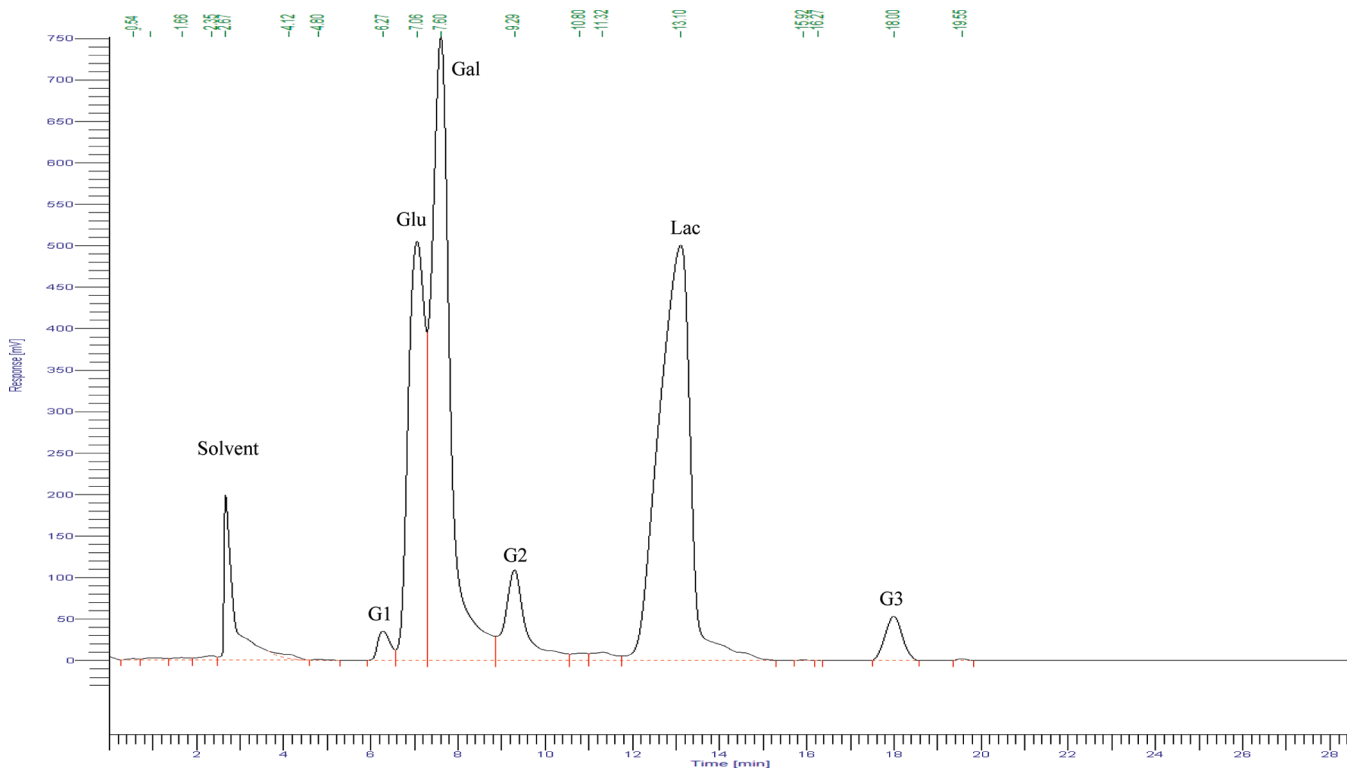

Figure 4. HPLC chromatogram of the reaction mixture in batch reactor (Glu, glucose; Gal, galactose; Lac, lactose; G1, G2, G3, galacto-oligosaccharides).

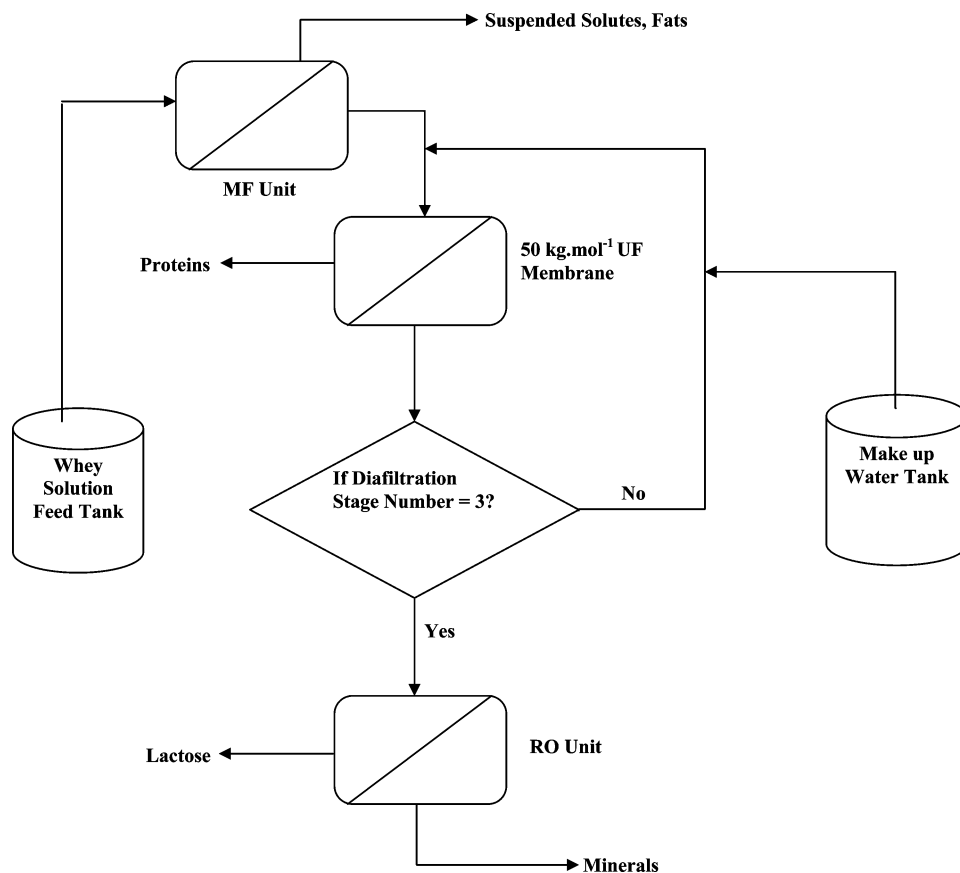

Figure 5. Schematic representation of lactose recovery from whey.

10^{-6} m^3 0.5 M NaOH, with total recirculation at a flow rate of $8.33 \times 10^{-7} \text{ m}^3 \text{ s}^{-1}$ for 1800 s, and then again kept in a total recirculation with $250 \times 10^{-6} \text{ m}^3$ for 600 s. It was observed that after wash water flux of the membrane was regained by

more than 96%. After that, the Vivaflow 200 module was stored with 10% (v/v) ethanol solution at 277 K temperature. TFC-SR2 membrane was also stored at 277 K temperature in acetate buffer.

Table 3. Composition of Different Streams from Different Membrane Units during Lactose Recovery from Whey

properties	UF feed $\times 10^3$	first stage UF permeate $\times 10^3$	diafiltration permeate $\times 10^3$	RO permeate $\times 10^3$	RO retentate $\times 10^3$
protein (kg m^{-3})	50	5.70 \pm 0.05	5.3 \pm 0.01	NA ^a	100 \pm 2.1
lactose (kg m^{-3})	300.1	298.7 \pm 1.2	60 \pm 0.5	trace	1330 \pm 15.3
ash/mineral (kg m^{-3})	3	3	1.2	1.2	13
COD (kg m^{-3})	89 100	16 000	12 035	NA ^a	1934

^a NA: not analyzed.

4. Analysis

4.1. Measurement of Chemical Oxygen Demand (COD).

COD of the feed, 5 kg mol^{-1} permeate, and retentate were measured using COD reactor (ET 108, Lovibond, Germany) and CHECKIT COD vario photometer to determine the organic compounds present in the sample contributing to the COD, photometrically.

4.2. Determination of Protein Content.

Protein contents of the feed, 5 kDa retentate, and permeate were determined according to the Folin–Lowry method of protein assay²⁵ at 750×10^{-9} m against appropriate blank. In brief, 5×10^{-6} m³ of alkaline solution, prepared after mixing 50×10^{-6} m³ of 2% Na₂CO₃ in 0.1 M NaOH and 1×10^{-6} m³ of 0.5% CuSO₄ in 1% sodium potassium tartarate solution, was added to the 1×10^{-6} m³ of test solution and kept for 600 s at room temperature. Diluted Folin–Ciocalteu reagent (0.5×10^{-6} m³) was rapidly added to the above solution with immediate mixing, allowed to stand for 1800 s, followed by the measurement at 750×10^{-9} m in UV visible spectrophotometer.

4.3. Determination of Sugar and Oligosaccharide Concentration.

Sugar and oligosaccharide concentrations were measured in HPLC equipped with RI detector. Figure 4 shows the separation peaks for monosaccharides, disaccharides, and oligosaccharides after chromatographic separation in HPLC.

4.4. Enzyme Activity Assay.

Enzyme activity was determined with neutral substrate lactose, following the method established by Splechna et al.²⁷ Following the method, 20×10^{-9} m³ of enzyme solution was added to 480×10^{-9} m³ of substrate solution, containing 600 mM lactose in 50 mM sodium phosphate buffer at pH 6. Incubation was continued for 600 s at 303 K. Reaction stopped by boiling the sample for 300 s. The amount of glucose released was measured in HPLC. One LU is defined as the amount of enzyme, which liberates 1×10^{-6} mol of glucose per minute from lactose at the early stage of reaction at 313 K and pH 6.

5. Results and Discussion

5.1. Recovery of Lactose from Whey.

Membrane-based technique for separation of protein from whey is a well-known technique that was reported by several authors.²⁸ Chollangi et al.²⁹ reported a detailed study on the preparation of whey protein concentrate using membrane-based technique. Figure 5 presents a schematic presentation of lactose recovery from whey. Table 3 shows the composition of different streams obtained from different filtration operation with 0.4 kg m^{-3} whey solution as feed. The lactose to protein ratio in the permeate stream was around 88.5% after the first stage of UF, and after the third stage of the diafiltration the ratio was almost 89.4%. Similar types of observations are also reported by Giacomo et al.³⁰ and Atra et al.³¹ The process was carried out at low whey concentration for better monitoring of the process parameters and to minimize the membrane fouling effect. Figures 6 and 7 show the effect of whey feed concentration on lactose yield and protein permeation, respectively. Percent lactose yield on permeate side increases with VCF at different concentrations of whey powder, but for 0.4 kg m^{-3} solution, a slight decrease

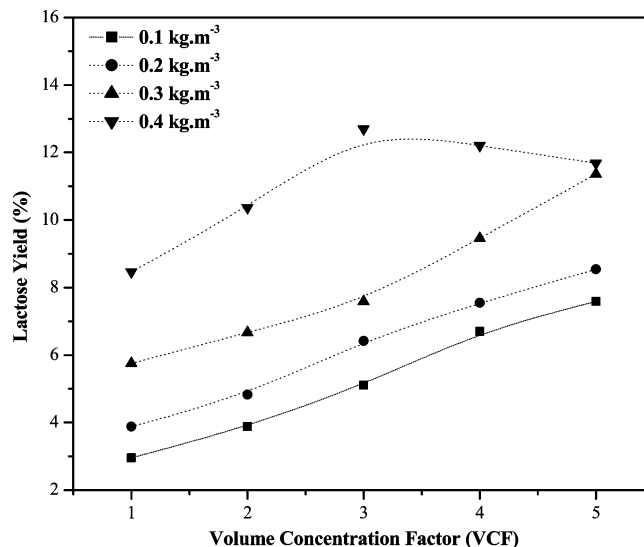

Figure 6. Variation of percentage yield of lactose with VCF on 5 kg mol^{-1} membrane retentate side for different feed solution at 0.2 MPa.

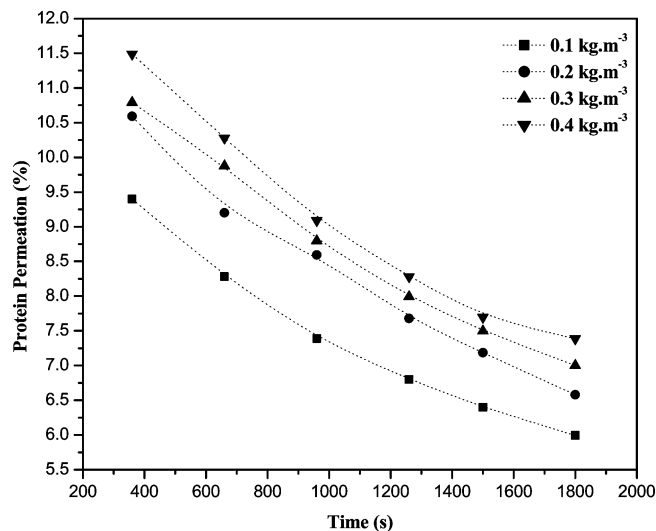

Figure 7. Variation of percentage protein permeation with time for 5 kg mol^{-1} membrane with VCF 4 and at TMP 0.15 MPa for different feed solution.

in yield is observed after VCF 3, which may be due to concentration polarization effect. Maximum yield (12.5%) of lactose on retentate side was obtained at VCF 3 and 0.2 MPa for 0.4 kg m^{-3} feed solution (Figure 6), and the total lactose yield on the permeate side was 89.22–95.54% up to VCF 5. Figure 7 shows the variations of the percent protein permeation in permeate with time at different concentrations of whey powder. It was found that protein content in the permeate was decreased in all the variations of the feed concentrations with time. This is mainly due to the formation of concentration polarization layer on the membrane surface, which exerts the secondary membrane effect and provides hindrance to the passage of protein molecules. After 1800 s, that is, at the end

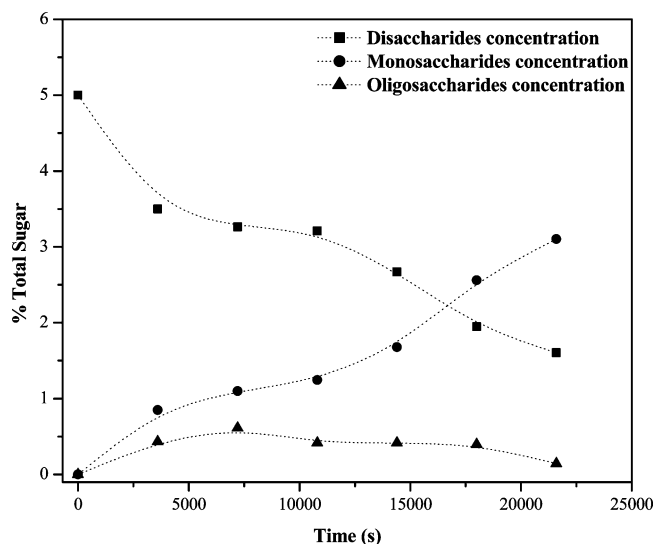

Figure 8. Variation % sugar concentration with time in batch reaction with 5% (w/v) initial lactose concentration at pH 4 and temperature 277 K with 0.1% (w/v) enzyme dosing.

of the run, the average fall in the protein content in permeate was found to be 35.88% at 0.15 MPa with VCF 4. With the increase in bulk concentration, protein permeation was also increased. Figure 7 presents that for 0.1, 0.2, 0.3, and 0.4 kg m⁻³ solutions, protein permeation values observed were 7.38%, 8.32%, 8.67%, and 9.05%, respectively. With increasing the concentration of the whey powder solution, the availability of the small protein/peptides in the feed increases, and thus percent protein permeation also increases. On average, 5.75–8.35% protein permeation was observed.

Chemical oxygen demand (COD) of any process stream is a measure of its polluting nature and should be very low before it is discharged into the environment. In the present study, COD of the feed solution was also decreased to a considerable degree after UF. Before the treatment, the COD value of the feed solution was 89.1 kg m⁻³ and was reduced to 16 kg m⁻³ after UF. Thus, an effective 82% reduction in the COD value of the UF permeate was achieved after the first stage, which was increased to about 86% after the third stage. After RO, the reduction was 97% in the permeate stream, showing an efficacy of the current technology in the treatment of wastewater enriched with whey. Hore et al.³² have also reported similar observations.

5.2. Factors Affecting the Production of Oligosaccharide in Enzyme Batch Reactor. Figure 8 shows the variation of 5% initial lactose concentration with time at pH 4 and temperature 277 K after 0.1% of enzyme was dosed into the batch system. From the figure, it can be observed with reaction time lactose was getting converted into monosaccharides and oligosaccharides. However, after a certain period, the concentration of oligosaccharides starts to drop, most probably as a result of the enhanced inhibitory effect of the monosaccharides. Glucose and galactose, produced during enzymatic hydrolysis of lactose, were reported to restrain the formation of oligosaccharides, when the concentration of the monosaccharides reaches a certain level.^{33,34} As the monosaccharides' concentration becomes higher than that of the oligosaccharides, glucose and galactose play a role of the competitive inhibitors during enzymatic hydrolysis of lactose. These observations have led to the development of a membrane reactor setup in which the monosaccharides produced during the hydrolysis of lactose can be continuously removed, during the reaction course, to

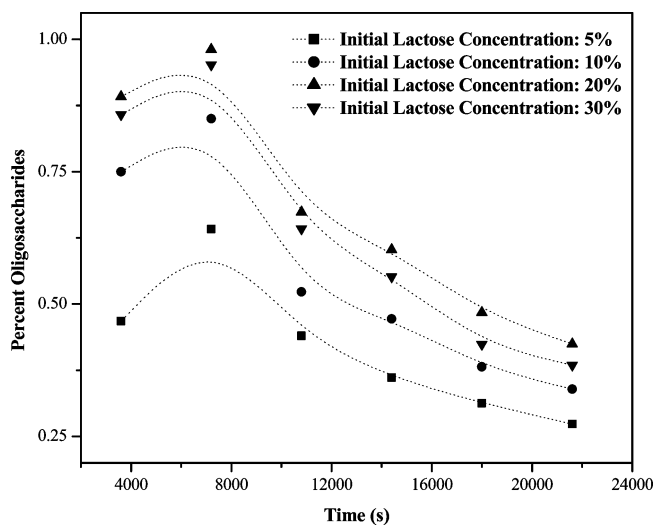

Figure 9. Effect of initial lactose concentration on GOS production with time in batch reactor at pH 4 and temperature 277 K with 0.1% (w/v) enzyme dosing.

eliminate the inhibitory effect of monosaccharides, and thus an improvement in the yield of GOS.

The maximum yield of oligosaccharides, which was around 30.6%, occurred for initial lactose concentration 20% (w/w) and 0.5% (w/w) enzyme concentration, at 277 K temperature and pH 6.6 at 7200 s reaction time and 67.5% degree of hydrolysis. The oligosaccharide concentrations increase during the first 7200 s of the reaction followed by a gradual reduction until 18,000 s, with a total yield of 19%. The reaction time is defined as the time at which the maximum formation of oligosaccharides occurred, and after which a decrease or no significant increase in the oligosaccharides concentration was observed. The yield (%) was the ratio of the oligosaccharides to the initial lactose concentration, expressed as a percentage. The degree of hydrolysis is the ratio between concentration of the total sugars formed (oligosaccharides and monosaccharides) and the initial concentration of lactose, expressed as a percentage.

5.3. Effect of Initial Lactose Concentration. The initial lactose concentrations have no influence on the reaction time during lactose hydrolysis (Figure 9). For all concentrations of lactose, maximum production of GOS was observed at 7200 s reaction period for fixed enzyme concentration of 0.5%. Maximum concentrations of oligosaccharides formed were significantly increased with the increasing initial lactose concentration. In this self-transferase reaction of lactose hydrolysis, the transgalactosyl activity of β -galactosidase is suggested to be strongly dependent on initial lactose concentration.³⁵ The maximum yield in GOS could be achieved when a major extent of lactose was already being hydrolyzed. Actually, the conversion of lactose to oligosaccharides requires the conversion of the donor to acceptor molecule. So, the highest amount of oligosaccharide was obtained with higher initial lactose concentration. Thus, a high concentration of lactose produced more glucose and galactose, which are likely to participate in the transgalactosylation³³ reaction and thus increased the oligosaccharide yield.

Changing initial lactose concentration from 5% to 20% shows an obvious increase in the GOS yield as observed from Figure 9. After that, with 30% initial lactose concentration there was a slight decrease in the yield, manifesting the production of more glucose, which inhibited the enzyme. As the glucose inhibition was more pronounced with β -galactosidase from *Bacillus*

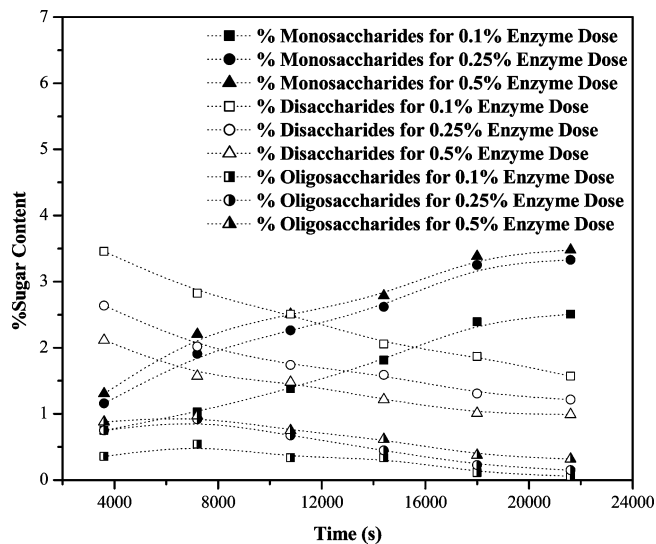

Figure 10. Effect of enzyme concentration on GOS production with time in batch reactor at pH 4 and temperature 277 K with 5% (w/v) initial lactose concentration.

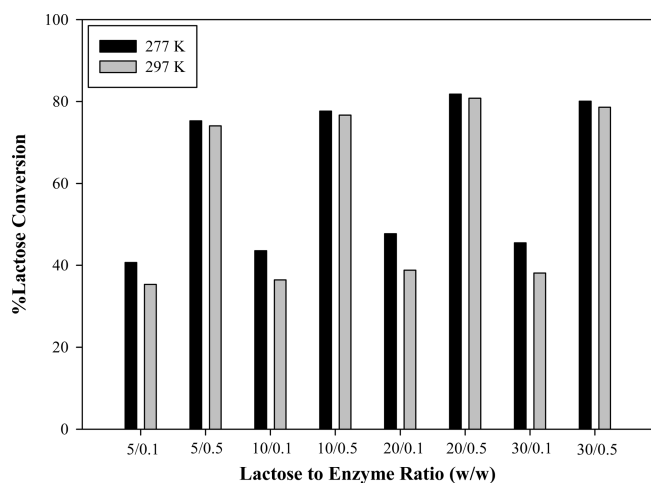

Figure 11. Effect of temperature on percentage lactose conversion after 7200 s at pH 6.6 for different lactose to enzyme ratio (w/w).

circulans,³⁶ so the increased glucose production attributed to the reduction in GOS yield.

5.4. Effect of Enzyme Concentration. Enzyme concentration is one of the critical factors to be considered during this enzymatic hydrolysis process in terms of yield as well as the cost of the production. Generally, in enzyme-catalyzed reactions, the reaction rate is directly proportional to the enzyme concentration, but some deviations from the expected result are observed during GOS production. No significant change in reaction time was observed with enzyme concentration. For a fixed concentration of lactose, with increasing enzyme concentration maximum GOS was achieved at 7200 s, but increased yield of the product and also a higher degree of hydrolysis were observed (Figure 10). With an increase in the enzyme concentration from 0.1% to 0.25%, GOS yield increased about 37.2%, whereas with a further increase in the enzyme dose up to 0.5%, yield increased only by 5% at 7200 s of reaction time. The overall increase in the enzyme concentration from 0.1% to 0.5% increment in the yield was 68%. Results show that the GOS yield was not proportionately changing with changing enzyme dose, manifesting the fact that an increase in the enzyme concentration also increases the rate of GOS hydrolysis and thereby lowers the GOS yield. Yet the degree of hydrolysis of

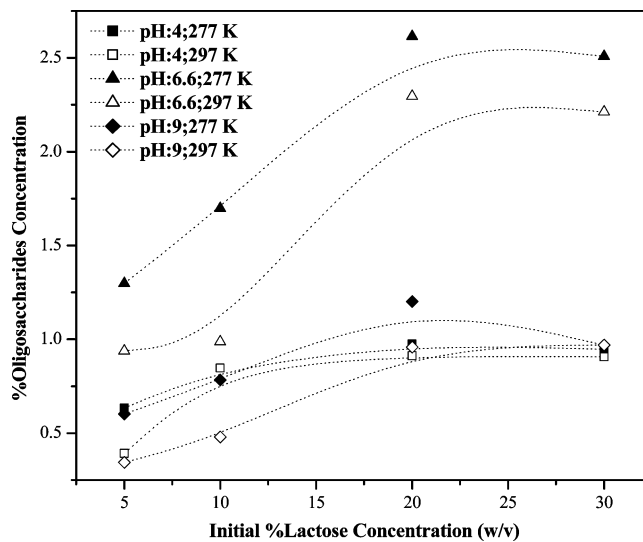

Figure 12. Variation of oligosaccharide concentration with lactose concentration at different pH values for 277 and 297 K for 0.1% (w/v) enzyme dosing.

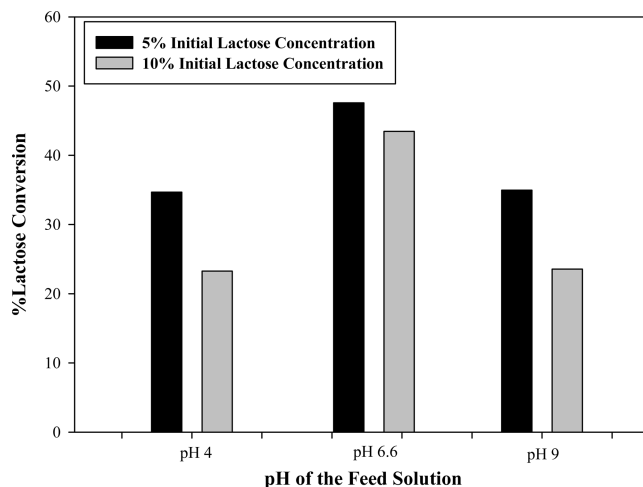

Figure 13. Effect of pH on percentage conversion of lactose after 7200 s with 0.1% (w/v) enzyme dose at temperature 277 K for different initial concentration of lactose.

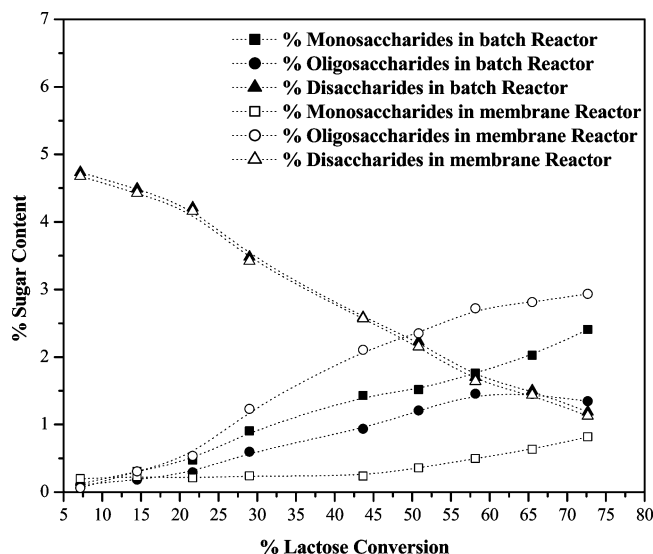

Figure 14. Variation of percentage sugar concentration with percentage lactose conversion for 5% (w/v) initial lactose concentration and 0.5% (w/v) enzyme concentration at pH 6.6 and temperature 297 K.

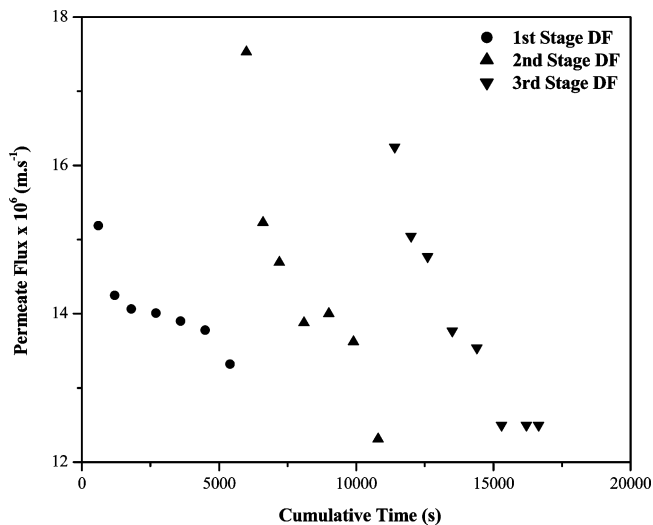

Figure 15. Variation of permeate flux with time for three-stage diafiltration for purifying GOS using NF in RDMM with membrane rotational speed 0.17 rps and volume concentration factor 1.5 under trans-membrane pressure 0.981 TMP.

lactose was changed proportionately with the increasing enzyme concentrations. Beyond the dose of 0.5%, no further effect on GOS yield was observed. Figure 11 shows the effect of lactose to enzyme ratio on lactose conversion at different temperatures. As is evident from Figure 11, the optimum ratio of lactose to enzyme was observed at 20:0.5 (w/w) for maximum conversion of lactose. A similar effect with the increasing enzyme concentrations on GOS yield was reported by Rustom et al.³⁷

5.5. Effect of pH and Reaction Temperature. Incubation temperature and the pH of the reaction mixture control the kinetics of the enzyme-catalyzed reaction as the enzyme activity largely depends on the pH value as well as on temperature. Maximum activity of the enzyme is reported by the supplier at

pH 6.6. In this course of reaction, the pH of the reaction mixture varied from highly acidic region (pH 4) to alkaline region (pH 9). Figures 12 and 13 show that the maximum lactose conversion was taking place at pH 6.6. Enzyme stability is also an important factor to be considered during the enzymatic reactions. It is already reported that β -galactosidase has good thermal stability and can catalyze the galactosyl transfer reaction at high temperature, although in our study the variation of the temperature was limited between 277 and 297 K. Results show that the GOS yield was higher at 277 K as compared to 297 K (Figures 11 and 12). At 4 °C, GOS production is about 13.6% higher than that at 297 K with 20% initial lactose concentration at pH 6.6 after 14,400 s of reaction time. Similar effects of temperature and pH are also reported by Lutzen et al.³⁸

5.6. GOS Production in Recycle Membrane Reactor. A comparative presentation of the results for monosaccharide and oligosaccharide production in batch reactor and in recycle membrane reactor is shown in Figure 14. In recycle membrane reactor, the yield of the GOS was increased gradually throughout the reaction in contrast to the batch reaction in which the production falls after 55% of lactose conversion. This difference in the behavior is due to the continuous removal of monosaccharide in permeate, thereby reducing the chances of inhibition. Similar types of observations are also reported by Czermark et al.³⁹ GOS production has been found to be 53.89% lower in batch reactor as compared to the membrane reactor, and the monosaccharide concentration was found 65.43% higher in batch reactor as compared to membrane reactor. After 14,400 s of reaction, the remaining enzyme solution activity measured was found to be 23% of the initial activity.

5.7. Purification of GOS Using Diafiltration-Assisted NF. Figure 15 shows a variation in the NF permeate flux with time at each stage of diafiltration for a membrane rotational speed of 0.17 rps maintaining a VCF of 1.5 and TMP 0.981 MPa. It is observed from the figures that there is an initial gain

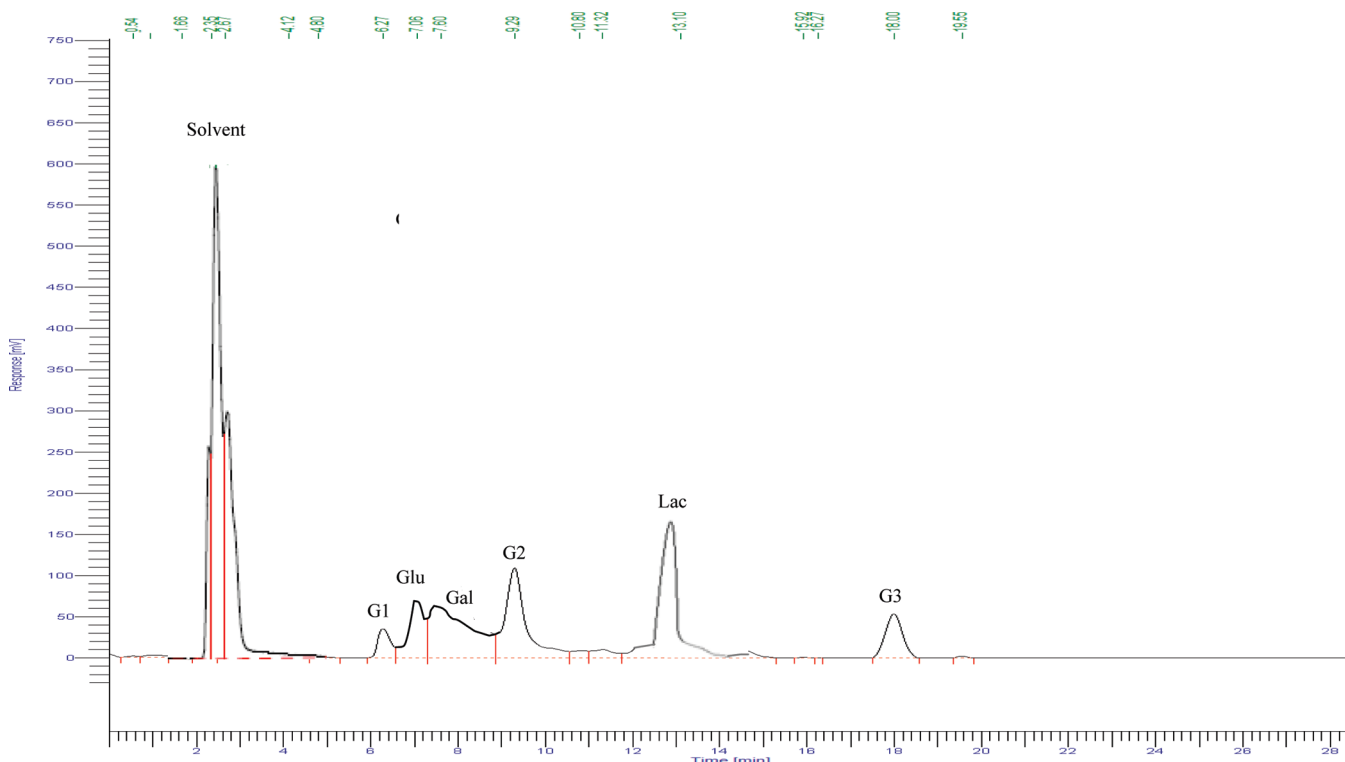

Figure 16. HPLC chromatogram of the retentate side reaction mixture after NF with utmost purity of GOS (Glu, glucose; Gal, galactose; Lac, lactose; G1, G2, G3, galacto-oligosaccharides).

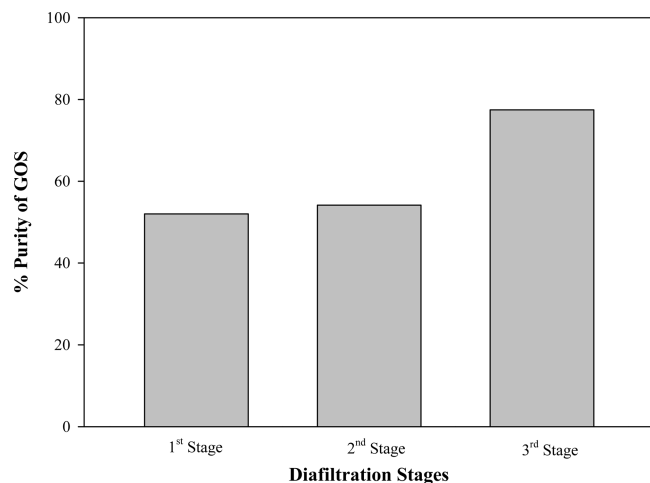

Figure 17. Variation of percentage purity of GOS with different diafiltration stages in NF with membrane rotational speed 0.17 rps and volume concentration factor 1.5 under trans-membrane pressure 0.981 TMP.

in the permeate flux at each stages, manifesting an additional effect of washing of the membrane surface because of dilution of the retentate portion and an alleviation of the deposition on the membrane surface, acting as a secondary membrane layer to the permeation of the microsolute. Surprisingly, in the third stage of the diafiltration, the initial permeate flux became very low as compared to the previous stage. This might be an indication of the insertion of the microsolute within the NF membrane interstices and thus creates an obstruction to the flow. Especially in the case of NF, this effect was much more pronounced as compared to UF or MF as the nanoscale structure of the NF membrane makes the process complicated and unpredictable. Yet with the subsequent dilution, shear stress and concentration polarization effects became low, resulting in an effective increase in the initial permeate flux. Figure 16 shows a HPLC chromatogram on the retentate side where the compositions of other sugars are displayed as compared to GOS, exhibiting maximum permeation of lower molecular weight sugars (di- and monosaccharides) with an ultimate increase in the GOS purity. Figure 17 shows that the percentage purity of GOS increases with the number of stages, implying the permeation of more di- and monosaccharides through NF membrane with dilution. From the figure, it can be observed that after the second stage of the diafiltration there is a sharp increase in the purity, ensuring maximum permeation of the lower molecular weight di- and monosaccharides through the membrane. Around 77% pure GOS was recovered at the third stage of the diafiltration at a membrane speed of 0.17 rps, manifesting the efficacy of the process.

6. Conclusion

Hydrolysis with neutral lactase Biolacta FN5 (EC 3.2.1.23) from *Bacillus circulans* of lactose initiates a comparable yield of oligosaccharides with 20% lactose concentration and 0.5% enzyme at 277 K with pH 6.6. Moreover, the uses of a membrane reactor setup where the monosaccharides produced during the hydrolysis of lactose are continuously removed, during the reaction course, eliminate the inhibitory effect of monosaccharide and thus improve the yield and efficiency of the process. Also, removal of some minerals from whey prior to hydrolysis by reverse osmosis might have increased the yield because they may adversely influence the enzyme activity. Finally, an effective 77% pure GOS was achieved with diafiltration-assisted NF. Moreover, a kinetic study would help

to understand the mechanism of the hydrolysis and thus lead to a proper design of the process. Other critical factors of continuous production of GOS, like residence time in the membrane recycle reactor, feed flow rate, and permeate collection rate, require optimization.

Acknowledgment

The work reported in this Article is part of an Indo-Australian project (vide sanction letter no. BT/PR9547/ICD/16/754/2006 of DBT/Indo-Aus/01/35/06 dated July 02, 2007), jointly funded by DEST (Australia) and DBT (India). The project involves collaboration between University of Melbourne and Burra Foods (Australia), and Jadavpur University and IIT Kanpur (India). Accordingly, the contributions of DEST (Australia) and DBT (India) are gratefully acknowledged.

Appendix – Diafiltration.

Diafiltration is a technique for reducing the deposited layer on the membrane by diluting the concentrated retentate with fresh solvent and thereby creating an online washing effect. In the present study, three-stage discontinuous diafiltration was carried out after maintaining a particular VCF. Initially, “ V, m^3 ” of the feed volume was taken, which will be reduced to “ V_R, m^3 ” after maintaining a VCF “ R ” and will obey the following relation.

$$R = \frac{V}{V_R} \quad (\text{A.1})$$

After one stage of the membrane filtration process was carried out, “ V_P, m^3 ” of the fresh solvent was added to the retentate side, where $V_P = V - V_R$, and again the next stage of the filtration was carried out.

Literature Cited

- (1) Barreteau, H.; Delattre, C.; Michaud, P. Production of oligosaccharides as promising new food additive generation. *Food Technol. Biotechnol.* **2006**, *44*, 323.
- (2) Rastall, R. A.; Gibson, G. R.; Gill, H. S.; Guarner, F.; Klaenhammer, T. R.; Pot, B.; Reid, G.; Rowland, I. R.; Sanders, M. E. Modulation of microbial ecology of the human colon by probiotics, prebiotics and symbiotics to enhance human health: An overview of enabling science and potential applications. *FEMS Microbiol. Ecol.* **2005**, *52*, 145.
- (3) Zopf, D.; Roth, S. Oligosaccharide anti-infective agents. *Lancet* **1996**, *347*, 1017.
- (4) Rycroft, C. E.; Jones, M. R.; Gibson, G. R.; Rastal, R. A. A comparative in vitro evaluation of fermentation properties of prebiotic oligosaccharides. *Lett. Appl. Microbiol.* **2001**, *91*, 878.
- (5) Palframan, C. E.; Gibson, G. R.; Rastal, R. A. Development of a quantitative tool for the comparison of prebiotic effect of dietary oligosaccharide. *Lett. Appl. Microbiol.* **2003**, *37*, 281.
- (6) Garrote, G.; Yáñez, R.; Alonso, J. L.; Parajó, J. C. Coproduction of oligosaccharides and glucose from corncoobs by hydrothermal processing and enzymatic hydrolysis. *Ind. Eng. Chem. Res.* **2008**, *47*, 1336.
- (7) Sako, R.; Matsumoto, K.; Tanaka, R. Recent progress on research and applications of nondigestible galactooligosaccharides. *Int. Dairy J.* **1999**, *9*, 69.
- (8) Boons, G. J. Synthetic oligosaccharides: Recent advances. *Drug Discovery Today* **1996**, *8*, 331.
- (9) Boons, G. J. Strategies in oligosaccharide synthesis. *Tetrahedron* **1996**, *52*, 1095.
- (10) Monson, P.; Paul, F. Enzymatic synthesis of oligosaccharides. *FEMS Microbiol. Rev.* **1995**, *16*, 187.
- (11) Sears, P.; Wang, C. H. Toward automated synthesis of oligosaccharides and glycoproteins. *Carbohydr. Glycobiol.* **2001**, *291*, 2344.
- (12) Grosová, Z.; Rosenberg, M.; Rebroš, M. Perspectives and applications of immobilised β -galactosidase in food industry - a review. *Czech J. Food Sci.* **2008**, *26*, 1.

- (13) Mozaffar, Z.; Nakanishi, K.; Matsuno, R.; Kamikubo, T. Purification and properties of β -galactosidase from *Bacillus circulans*. *Agric. Biol. Chem.* **1984**, *48*, 3053.
- (14) Nakao, M.; Harada, M.; Kodama, Y.; Nakayama, T.; Shibano, Y.; Amachi, T. Purification and characterization of a thermostable β -galactosidase with high transgalactosylation activity from *Saccharopolyspora rectivirgula*. *Appl. Microbiol. Biotechnol.* **1994**, *40*, 657.
- (15) Dumortier, V.; Brassart, C.; Bouquelet, S. Purification and properties of a β -D-galactosidase from *Bifidobacterium bifidum* exhibiting a transgalactosylation reaction. *Biotechnol. Appl. Biochem.* **1994**, *19*, 341.
- (16) Onishi, N.; Tanaka, T. Purification and properties of a novel thermostable galacto-oligosaccharide producing β -galactosidase from *Sterigmatomyces elviae* CBS8119. *Appl. Environ. Microbiol.* **1995**, *61*, 4026.
- (17) Lipnizki, F.; Boelsmand, J.; Madsen, R. F. Concepts of industrial-scale diafiltration systems. *Desalination* **2002**, *144*, 179.
- (18) Agenson, K. O.; Urase, T. Change in membrane performance due to organic fouling in nanofiltration (NF)/reverse osmosis (RO) applications. *Sep. Purif. Technol.* **2007**, *55*, 147.
- (19) Jarusutthirak, C.; Mattaraj, S.; Jiratananon, R. Factors affecting nanofiltration performances in natural organic matter rejection and flux decline. *Sep. Purif. Technol.* **2007**, *58*, 68.
- (20) Foda, M. I.; Lopez-Leiva, M. Continuous production of oligosaccharides from whey using a membrane reactor. *Process Biochem.* **2000**, *35*, 581.
- (21) Bund, R. K.; Pandit, A. B. Rapid lactose recovery from buffalo whey by use of anti-solvent, ethanol. *J. Food Eng.* **2007**, *82*, 333.
- (22) Nghiem, L. D.; Hawkes, S. Effects of membrane fouling on the nanofiltration of pharmaceutically active compounds (PhACs): Mechanisms and role of membrane pore size. *Sep. Purif. Technol.* **2007**, *57*, 182.
- (23) Bhattacharjee, C.; Sen, D.; Sarkar, P.; Datta, S.; Bhattacharya, P. K. Studies on the application of different ANNs to predict permeate flux in rotating disk membrane modules: A case study with MATLAB. *Desalin. Water Treat.* **2009**, *2*, 170.
- (24) Albayrak, N.; Yang, S.-H. Immobilization of β -galactosidase on fibrous matrix by polyethyleneimine for production of galacto-oligosaccharides from lactose. *Biotechnol. Prog.* **2002**, *18*, 240.
- (25) Lowry, O. H.; Rosebrough, N. J.; Farr, A. L.; Randal, R. J. Protein measurement with folin phenol reagent. *J. Biol. Chem.* **1951**, *193*, 265.
- (26) Das, R.; Bhattacharjee, C.; Ghosh, S. Effects of operating parameters and nature of fouling behavior in ultrafiltration of sesame protein hydrolysate. *Desalination* **2009**, *237*, 268.
- (27) Splechtina, B.; Nguyen, T.-H.; Steinbock, M.; Kulbe, K. D.; Lorenz, W.; Haltrich, D. Production of prebiotic galacto-oligosaccharide from lactose using β -galactosidase from *Lactobacillus ruteri*. *J. Agric. Food Chem.* **2006**, *54*, 4999.
- (28) Bhattacharya, S.; Bhattacharya, C.; Datta, S. Studies on the fractionation of b-lactoglobulin from casein whey using ultrafiltration and ion-exchange membrane chromatography. *J. Membr. Sci.* **2006**, *275*, 141.
- (29) Chollangi, A.; Hossain, Md. M. Separation of proteins and lactose from dairy wastewater. *Chem. Eng. Process.* **2007**, *46*, 398.
- (30) Giacomo, G. D.; Re, G. D.; Spera, D. Milk whey treatment with recovery of valuable products. *Desalination* **1996**, *108*, 237.
- (31) Atra, R.; Vatai, G.; Molnar, E. B.; Balint, A. Investigation of ultra- and nanofiltration for utilization of whey protein and lactose. *J. Food Eng.* **2005**, *67*, 325.
- (32) Hore, A.; Sarkar, P.; Sarkar, M.; Bhattacharjee, C.; Datta, S. Membrane technology in recovery of protein from whey stream: A safe and economic route to whey disposal. *Indian J. Environ. Prot.* **2007**, *27*, 883.
- (33) Prenosil, J. E.; Stuker, E.; Bourne, J. R. Formation of oligosaccharides during enzymatic lactose hydrolysis and their importance in a whey hydrolysis process II. *Exp. Biotechnol. Bioeng.* **1987**, *30*, 1026.
- (34) Iwasaki, K.; Nakajima, M.; Nakao, S. Galacto-oligosaccharide production from lactose by an enzymatic batch reaction using beta-galactosidase. *Process Biochem.* **1996**, *31*, 69.
- (35) Roberts, H. R.; Pettinati, J. D. Oligosaccharides production, concentration effects in the enzymatic conversion of lactose to oligosaccharides. *J. Agric. Food Chem.* **1957**, *5*, 130.
- (36) Boon, M. A.; Janssen, A. E. M.; Padt, A. V. D. Modelling and parameter estimation of the enzymatic synthesis of oligosaccharides by β -galactosidase from *Bacillus circulans*. *Biotechnol. Bioeng.* **1999**, *64*, 558.
- (37) Rustom, Y. S.; Foda, M. I.; Lopez-Leiva, M. H. Formation of oligosaccharides from whey UF-permeate by enzymatic hydrolysis - analysis of factors. *Food Chem.* **1998**, *62*, 141.
- (38) Lutzen, N. W.; Norman, B. E. Comparison of β -galactosidase from *Kluyveromyces fragilis* and *Bacillus* sp. and their application in whey treatment. In *Food Process Engineering*; Linko, P., Larinkari, J., Eds.; Applied Science Publishers: London, 1980.
- (39) Czermak, P.; Ebrahimi, M.; Grau, K.; Netz, S.; Sawatzki, G.; Pfromm, P. H. Membrane assisted production of galactosyl- oligosaccharides from lactose in a continuous process. *J. Membr. Sci.* **2004**, *232*, 85.

Received for review July 31, 2010

Revised manuscript received November 11, 2010

Accepted November 18, 2010

IE1016333